

## How real electric motors work

John Storey

**Note:** These pages are intended to be read in conjunction with Joe's "Electric motors and generators" pages (<http://www.animations.physics.unsw.edu.au/jw/electricmotors.html>). Read those pages first. Once you've got the basic idea and understand the physical principles and the maths, you're ready to explore how real-life engineers have put physics into action to make our lives easier.

When it comes down to it, all these motor are using the same basic principle. In some cases, it's easiest to think in terms of the force on a current-carrying wire in a static magnetic field. In other cases it's easiest to think about two magnets (at least one of which is an electromagnet) attempting to align their poles north-to-south and south-to-north. However, both these explanations amount to the same thing, as James Clerk Maxwell so elegantly described with his four equations that form the basis of electromagnetism. [http://www.phys.unsw.edu.au/einsteinlight/jw/module3\\_Maxwell.htm](http://www.phys.unsw.edu.au/einsteinlight/jw/module3_Maxwell.htm)

If you're tempted to pull a motor apart yourself, please think carefully about the risks involved before reaching for the tool kit. Some of the more important risks are listed at the end of this article.

Click on any picture for a high-resolution image. All pictures may be freely reproduced for educational purposes provided they are appropriately acknowledged.

1. Induction motors
2. "Universal" motors
3. Advanced AC motors
4. "Conventional" DC motors
5. Printed circuit motors
6. Brushless DC motors
7. Stepper motors
8. The infamous "ball-bearing" motor
9. Taking motors apart.

## 1. Induction motors

No modern home should be without one – or maybe a dozen. You'll find an induction motor in the fan, fridge, vacuum cleaner, washing machine, dishwasher, clothes drier, and the little pump that circulates water in the fish tank to stop the water turning green and the fish going belly-up. Chances are there's also one in the air conditioner – unless it's a particularly high-tech one.

Advantages:

- Cheap
- Quiet
- Long lasting
- Creates no interference

Disadvantages:

- Wants to turn at constant speed (50Hz divided by half the number of poles)
- Cannot turn faster than 1500rpm (4-pole motor)
- Draws a massive starting current, or is inefficient, or both
- Kind of big and bulky for the power it develops

This one came out of a fan.



Actually, the bearings and end-caps of the motor have already been removed. (In retrospect, I should have used something more delicate than an axe to disassemble the fan.) We can pull the rotor out and this is what we're left with. There are four windings, and they are all simply in series.

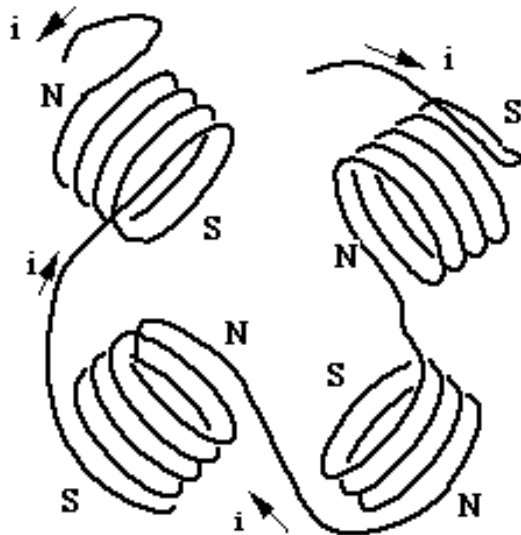

Well, not quite simply – the current comes in the white wire, then the first winding (top right) is clockwise, the next one (bottom right) is anticlockwise, bottom left is clockwise again, top left is anticlockwise, then out the other white wire. So, imagine a positive half-cycle of the mains, with the current actually coming in that first wire. The first winding produces a north pole facing in; the second a south pole facing in; etc, like this: N-S-N-S.

Half a mains cycle later (10 ms) the current has reversed and so must the magnetic sense of the poles, which are now: S-N-S-N. The rotor is an electrical conductor, and therefore tries to follow this field. To do so it has to rotate through 90 degrees. The rotor thus takes two full cycles of the mains (40 ms) to make a complete rotation, and so revolves at 1500 rpm. At least, it would if it could keep up with the rotating field. But it can't, quite, and in fact it's only because it's slipping behind that any torque is developed at all. So, it rotates a bit slower than 1500 rpm (typically 1440 rpm) depending on how much torque it is being called upon to produce.

Note that the motor, as described so far, could rotate happily clockwise or anticlockwise. This kind of motor therefore needs some kind of internal cleverness to ensure it only turns in the right direction. This is achieved, in this motor, by the use of *shaded poles*.

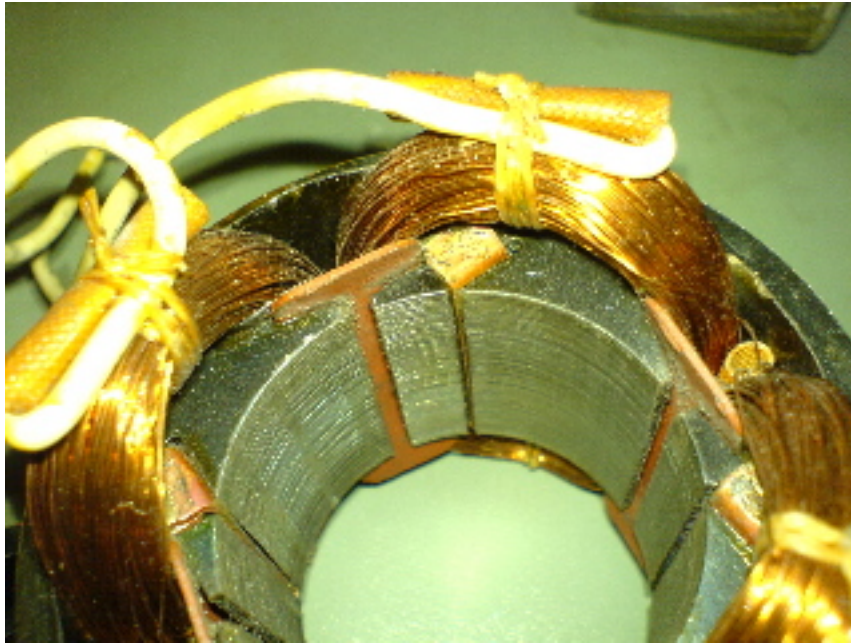

Notice the winding at the top of the picture. See how there is a small additional pole (or set of iron laminations) off to the left of the main pole. It's excited by the same winding as the main pole, but is "shaded" from it by a thick copper and that wraps around the laminations and acts like a shorted electrical turn. The current induced in this band by the magnetic field generates a phase shift so that the shaded pole can generate a small component of magnetic field at right angles to the main field, and with the correct phase to ensure the fan turns the right way (otherwise the fan would suck instead of blowing).

So in fact our induction motor is using induction already, and we haven't even got to the rotor yet!

Now we look at the rotor. This is a real disappointment – it looks nothing like the "squirrel cage" in the text book! Where's the squirrel supposed to go, for starters?



What's happened here is that the rotor is actually made up of a stack of disc-shaped laminations of soft iron. That's right – it's solid. This concentrates the magnetic field (generated by the windings) into the region where it will do the most good (the conducting bars of the rotor).

You can actually see the edges of the bars that run along the axis of the rotor, but they're at an angle of maybe 30 degrees to the shaft. What's going on here? Bad day at the factory? Chances are it's been designed that way to reduce *cogging torque*. If the bars ran parallel to the axis, the torque would rise and fall as each bar passed under the windings. By slanting the bars, the torque is kept more uniform as the rotor turns.

Now let's look at a different type of induction motor.



This induction motor came out of an astronomical telescope. It was part of the photographic film transport, and needed to be able to turn both forwards and backwards. It therefore has two separate windings, and four wires coming out. One winding is fed directly from the mains (or "*line*" as our US colleagues call it); the other is fed through a capacitor that provides the necessary 90 degree phase shift. Swap the windings over, or reverse the connections to one of the windings, and the motor goes the other way.

No surprises when we take it apart, although note a very different winding pattern to the previous motor. It has more poles, and therefore turns slower.



Once again, the rotor is solid, and we can't see what's inside. The aluminium plate at the end of the rotor has been stamped and turned up into a series of small fins to make a crude cooling fan. (This wasn't necessary with our first motor – it kept itself cool by the simple expedient of placing itself in the middle of, well, a fan.)



Since astronomical telescopes no longer use film, we may as well cut the rotor in half and see if there's a squirrel in there.



No squirrel, but a magnificent set of aluminium conducting bars, just like in the text books. If you think of the rotor bars as forming (via the end rings) a single-turn secondary winding of a transformer, the primary of which (the windings on each pole) has some 50 ~ 100 turns, it is clear that the current through the rotor bars can be very high – as much as 100 amps for a 240 watt motor. This explains the need for really chunky bars!

One disadvantage of the shaded pole motor is that the *starting torque* is rather low. This doesn't matter for something like a fan, where the load when stationary is almost zero. For other applications, like a washing machine, it would be a disaster. Such motors therefore use a capacitor to generate the required phase shift for the quadrature windings, as in this example.

Induction motors also come in other variations, but the two described above are the most common in domestic use.

For serious grunt, however, you need a *three-phase* induction motor. This takes advantage of the fact that commercial 3-phase power is delivered by three conductors, each of which carries a 50 Hz sine wave with 120 degrees of phase shift relative to the other two [See <http://www.phys.unsw.edu.au/~jw/power.html> 3 phase power]. A 3-phase motor simply places three windings at 120 degree intervals around the casing, and a rotating magnetic field is automatically produced. Three-phase induction motors are the “workhorse” of industry, with large units having ratings well in excess of a megawatt.

Sydney's new Millenium trains use 3-phase induction motors, each rated at 226 kW, breaking away from the traditional DC motors used on Tangara trains and earlier models. However, since the overhead power to the train is 1500 volts DC, each Millenium train must use an *inverter* to create the three AC phases to feed to its motors.

## 2. "Universal" motors

No home should be without a dozen or so of these as well. They'll be where you want something compact that spins fast (food processor, coffee grinder, electric nose-hair trimmer) or needs variable speed (sewing machine, hand-held electric drill).

Advantages:

- Will turn at any speed you want it to, including really fast
- A lot of power in a small package

Disadvantages

- Horrible
- Arcing brushes create radio interference, ozone, noise.

A universal motor has both a wound field (on the stator) and a wound armature (on the rotor). It cannot use a permanent magnet to create the stator field because it needs to reverse its magnetic polarity every half cycle of the mains. The voltage being fed to the commutator brushes is also changing polarity every half cycle, and in fact is simply in parallel with the field winding.

This one ran for 30 years in a sewing machine.



Note the brushes at the right hand end of the shaft. To look at, it's almost indistinguishable\* from a DC motor. In fact, it will run quite happily on DC. However, unlike a permanent magnet motor, a universal motor will always turn in the same direction, regardless of which way round it's connected to the DC source. Knowing this simple fact can sometimes enable you to win bets involving small amounts of money.

This motor only has two poles, and so does not have a lot of starting torque. That's why you sometimes need to turn the big wheel on the end of the sewing machine to get it started.

\*Somewhat astute readers will notice that, unlike a conventional DC motor, it has a laminated stator. Totally astute readers will also understand why.



### 3. Advanced AC motors

The compressor motor in an airconditioner is the thing that draws most of the current. Obviously it should be as efficient as possible, and it would be desirable to be able to run it at varying speeds depending on the required load. With its miserable efficiency and lack of enthusiasm for running at anything but one particular speed, a single-phase induction motor is a poor – if inexpensive – choice.

Many modern airconditioners therefore instead use “Inverter” technology. What this means is that they rectify the mains to create DC, then use an inverter, or *DC to AC converter*, to go back to AC again. However, the AC that is produced is no longer at 50Hz, but is at a variable frequency. Even if we just used a conventional induction motor now we’d be ahead, because we’ll be driving it at the optimum frequency, and hence rotational speed, for the required load. However, we can go one better than this and use a *switched reluctance motor* (which has a rotor made from soft iron) or a *brushless DC motor* (which has a permanent-magnet rotor), and achieve even higher efficiencies. It is one of the strange perversities of life that we will now call this a DC motor, even though it’s quite decidedly running off AC!

Advantages:

- Can be optimised for task
- Can be much more efficient
- Can run at variable speed
- Can last forever

Disadvantages:

- Expensive (relative to a simple induction motor)
- Requires complex drive electronics
- Takes longer to explain than simple motors



Look closely and you'll see the word "*inverter*" on the box.

(I don't yet have any good pictures of the insides of a switched reluctance motor, but I'm working on it...)

#### 4. “Conventional” DC motors

There are plenty of these in the average household, lurking inside battery powered toys, the cassette player, cordless drill and electric toothbrush. Inside a car, everything from the cooling fan to the windscreen wipers will have a DC motor. In fact, a luxury car with electric headlight washers, electric seat adjustment and remote rear-vision mirrors has more electric motors than you can poke a stick at – an interesting competition is to simply to count them and see who can find the most!

Advantages:

- Reasonably inexpensive
- Easy to control
- Adaptable

Disadvantages:

- Brushes eventually wear out
- Brushes create electrical interference
- Brushes are bad

Most DC motors look something like this. This particular one is beautifully made and probably cost at least a lot of money.



However, that won't stop us taking it apart.



Starting at the left we have the end cap and the two carbon brushes that contact the commutator, then the rotor, the stator casing and its two C-shaped permanent magnets, the gearbox housing, a little gear-wheel that fell out of somewhere, and the gear-head and output shaft.

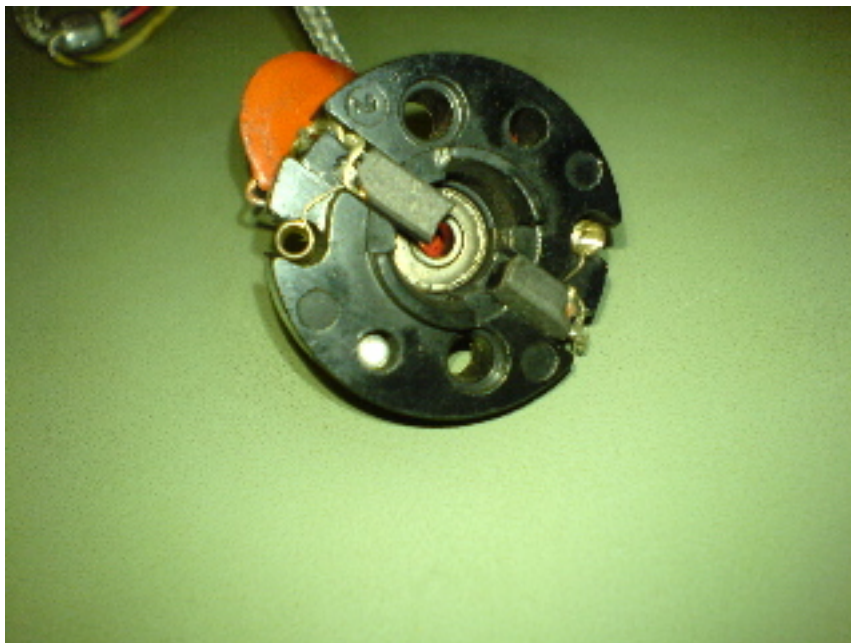

The two brushes are solid blocks of graphite, and are pressed against the commutator by the two small coil springs (situated slightly anticlockwise of the brushes). The orange disc is a capacitor that is directly across the power supply to the motor and helps to reduce radio interference caused by sparking where the brushes contact the commutator.



The rotor is very simple...

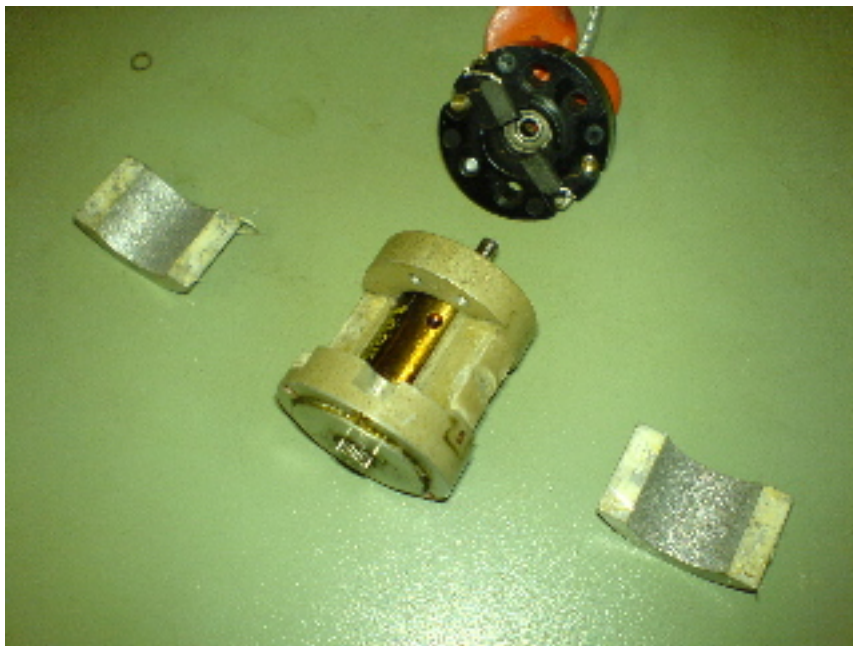

...and goes in an equally simple housing with two “C” shaped magnets. The housing is made of soft iron and creates the *magnetic poles* of the stator.

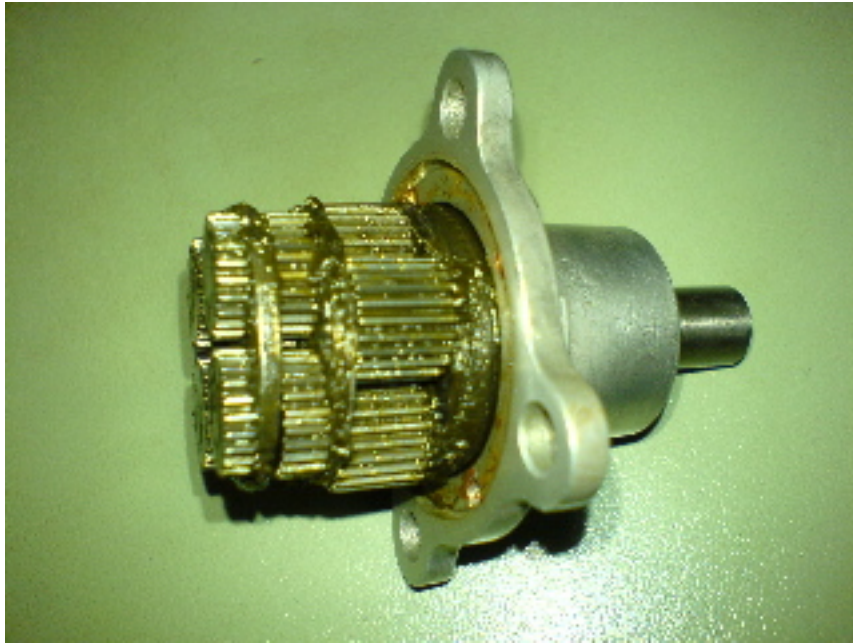

The best thing about this motor is the multi-stage planetary gearbox on the end!

## 5. Printed circuit motors

Sometimes called "pancake motors", these are a particular cunning motor configuration whose operation is in some ways easier to visualise than that of a conventional motor. They fit into confined spaces (say inside a car door, to make the windows go up and down) and, because the rotor is light and has little rotational inertia, can accelerate to full speed and stop again very rapidly. This feature isn't so important for car windows (unless you're into drive-by shootings), but is essential for industrial robots and other servo mechanisms.

Advantages:

- Efficient – no hysteresis or "iron" loss
- Very low rotational inertia
- Light weight
- Flat, so fits into confined space.

Disadvantages:

- Expensive to make
- Armature has little mass, and therefore can overheat quickly

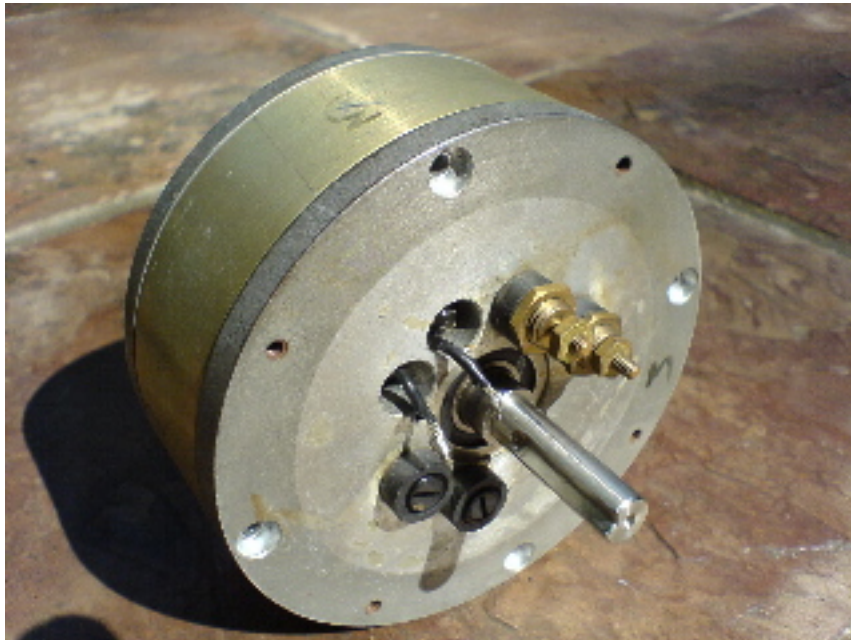

This is what a typical printed circuit motor looks like. Don't worry about the two black wires for the moment.



This is what's inside. Glued to each "face" of the motor are (in this case) eight magnets. Their poles alternate N-S-N-S etc as you go around.



Here's the other face, with its eight magnets. These line up exactly (north to south) with the magnets on the other face, creating a strong magnetic field across the gap where the rotor sits. (Try not to think about that black wire for the moment.) So, now we've set up a strong magnetic field running *axially* (ie, parallel to the motor shaft). That field threads back and forth eight times through the small gap that will be occupied by the rotor when we put it all back together. (Note that the end faces are made of iron and complete the magnetic circuit.)

Now, if the magnetic field is parallel to the shaft, and we want a tangential force on the rotor, which way does the current have to be flowing? Well, it has to be at right angles to both, and therefore *radial*.

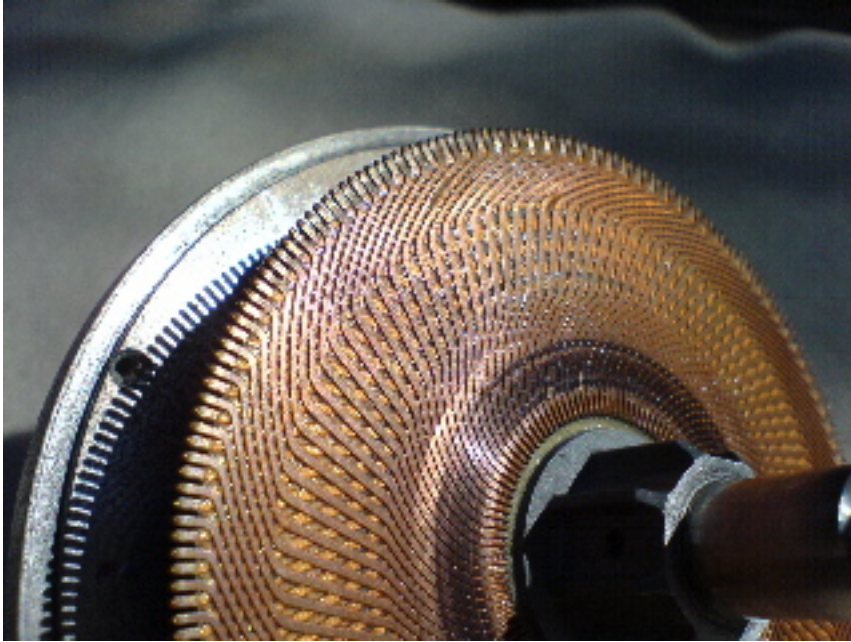

Now it should all make sense. The brushes contact the rotor on that blackened area near the shaft. The current goes out along the copper wire, and is travelling almost radially as it goes through the region of highest magnetic field. (*Almost radial but not quite, to reduce cogging torque.*) So, a force is exerted on the wire that is at right angles to the wire and at right angles to the magnetic field, causing the rotor to turn. Now, if the wire just turned around and came back in towards the shaft again, the force on the bit coming back would be equal and opposite to what it was going out, cancelling out any useful torque and the whole thing would just sit there with smoke pouring out of it. So, once the wire has gone out past the magnet, let's take it over diagonally to the right and bring it back in to the shaft past the *next* magnet which, you'll recall, has its magnetic field in the opposite orientation. Now the force on the returning piece of wire will *add* to the torque, and away we go.

Once back on the blackened piece of rotor the current can pass out through the second brush and back to the battery or whatever it is that's powering the robot.





Try not to think about the black wire for a moment. In this picture you can see the two brushes. They simply rub on the rotor which, as you saw, consists simply of a flat piece of insulator with copper lines etched or stamped on it, like a printed-circuit board. The other side of the brushes ends up as brass terminals on the outside of the motor, as in the first photo.

So there we have it. The only problem now is that the magnets themselves cannot retain their strongest permanent field unless they are always in a completed magnetic circuit. So, you can't magnetise them and *then* assemble the motor. But, once you've assembled the motor, you can't get at them to magnetise them. So, we can't actually build this kind of motor. Pity, really, it was looking rather promising.

But wait a moment! Suppose we thread a black\* wire back and forth between the magnets, as in the picture above. Let's bring the wire outside the motor, and once everything is assembled we zap a gazillion amps through the wire. Think about what direction the magnetic field created by the current through that wire will be in. Perfect! Admittedly it's not a very thick wire to be coping with such a large current (typically several thousand amps), but it's only for a few milliseconds and the wire doesn't have time to complain. Also, it only has to happen once...

\*Actually, any colour would do.

## 6. Brushless DC motors

Instead of having the magnets on the stationary casing and the windings on the rotor, we could put the magnets on the rotor and the windings on the stator. That way, we won't need brushes at all because the winding is stationary. However, now we need to find a way to switch the current through the windings at the right moment to ensure the torque on the rotor is always in the same direction. In a conventional motor, this happens automatically as the commutator acts as mechanical switch. With a brushless motor, we need some way to sense the position of the rotor, and then electronically switch the current so it's going the right way through the right winding.

Brushless motors are found in computer hard drives, CD and DVD players, and in anything else where efficiency and reliability are more important than price. As the cost of electronics continues to come down, perhaps one day all DC motors will be built this way.

Advantages:

- No brushes
- Simple
- Efficient
- Windings are attached to the casing, and easier to cool.

Disadvantages:

- Requires complex drive electronics

In fact, brushes are bad news. True, they're a clever way to ensure that, as the rotor turns, the current is automatically switched around the windings to ensure the motor keeps turning. However, everything else about them is bad: they are noisy, create friction, generate electrical interference (because of the sparking) and reduce efficiency (because there will always be a voltage drop across the brushes). Not only that, but they eventually wear out. With modern electronics, we can instead sense the position of the rotor (for example, with a Hall-effect device), then switch the current with, for example, a MOSFET transistor.

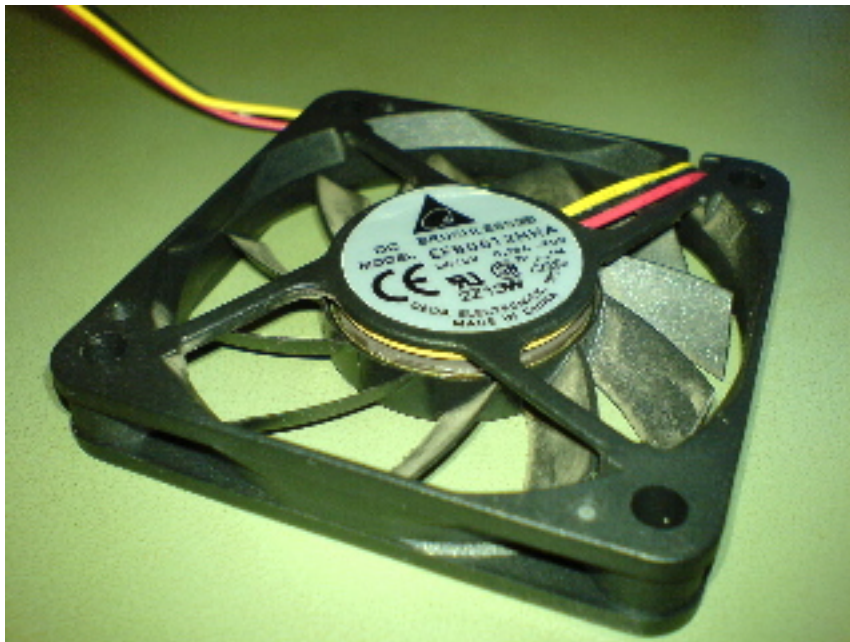

This is a fan that spent most of its life inside a computer keeping the microprocessor cool. It runs off 12 volts DC and has a brushless motor, as it thoughtfully explains with large friendly letters on the label.

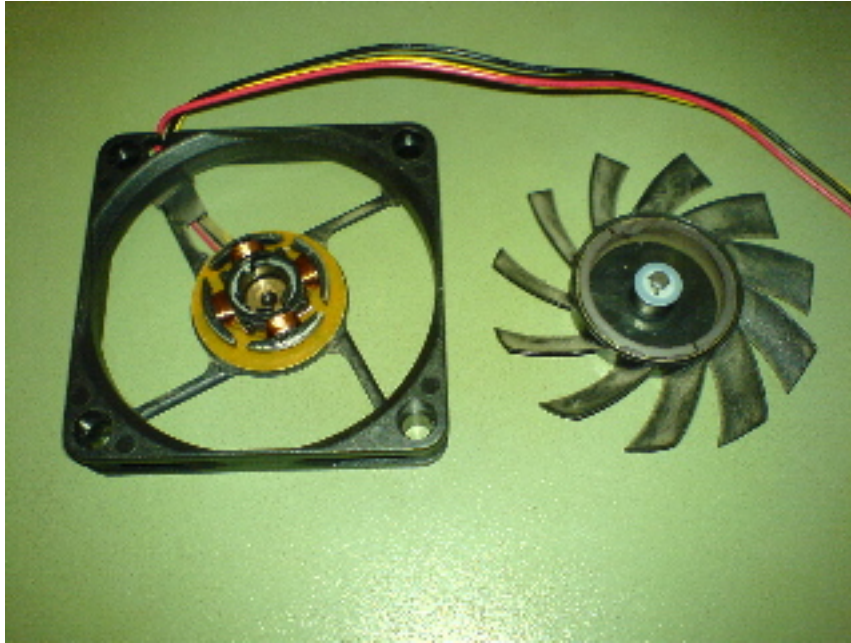

As promised, the magnets are on the rotor (with fan blades attached) in a ring around the outside of the hub. By “feeling” them by using a small compass as a probe, we find that there are four poles, running N-S-N-S around the ring.



The “stator”, in the centre, has four small coils with shaped pole pieces to create a strong magnetic field next to the rotor. Depending on which direction the current flows through each coil, it will attract or repel a north pole. So, all we have to do is to keep switching the direction of current flow through the coils in synchronisation with the rotation of the magnets, and we’ll keep exerting a torque that keeps the fan turning.



Now we've peeled the label off and can see the electronics that does the switching. It consists of a single integrated circuit and a few small capacitors, so it's actually not all that complex! If we google the part number of the chip (LB1962M), we find it is a "*Fan motor single phase full-wave driver*", which I guess is reassuring.

But how does the motor know the exact moment that the magnet has passed one pole, and therefore that it's time to reverse the current flow? There are three techniques commonly used:

- Hall-effect sensors. This is a neat, non-contact way of knowing where the magnets are.
- Back EMF. This is even neater. We don't use sensors at all, but use the fact that the magnet moving past the coil will induce a voltage in it, and use this voltage to tell us where the magnet is.
- Don't bother. For the ultimate minimalist approach, just keep switching the coils in sequence and assume the rotor will keep up. For motors with a small load that is well defined (eg, a fan), this works pretty well.

## 7. Stepper motors

Stepper motors are useful for positioning things. Unlike a conventional DC motor that just goes round and round when you apply power to it, a stepper motor requires that the current through its two or more windings changes in a specific sequence. Each time this sequence is carried out, the stepper motor makes one step, clockwise or anticlockwise. With an appropriate piece of digital logic (or a computer) providing an appropriate number of repetitions of the sequence, the motor will move through the required angle. Stepper motors are used to move the paper in printers, to position the read heads on disc drives, and in simple servo systems.

Advantages:

- Move in discrete, well defined steps
- Stay put when you remove the power

Disadvantages:

- Require complex drive electronics
- Not terribly efficient

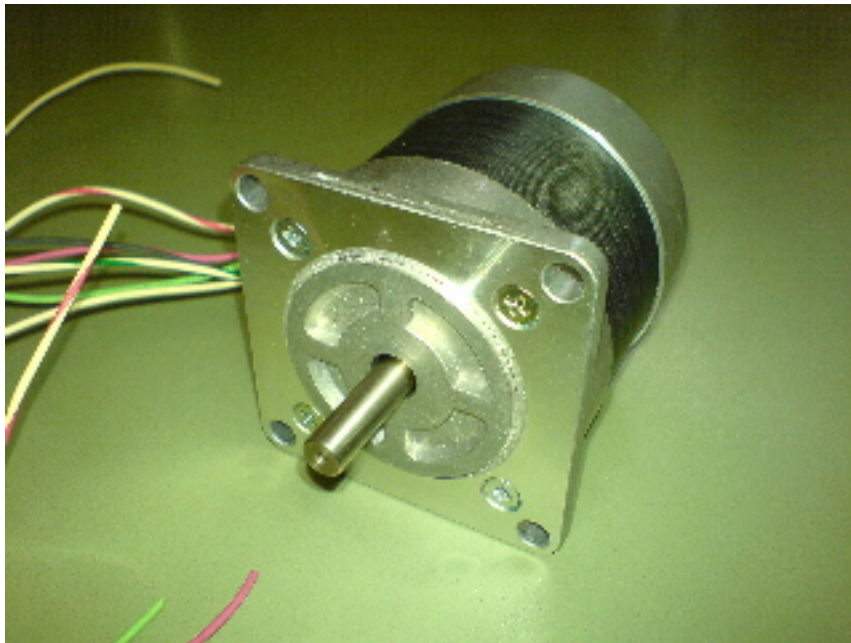

This particular motor steps 1.8 degrees at a time. It is an example of a *hybrid* stepper motor, one that has a magnetised rotor that also has iron teeth.

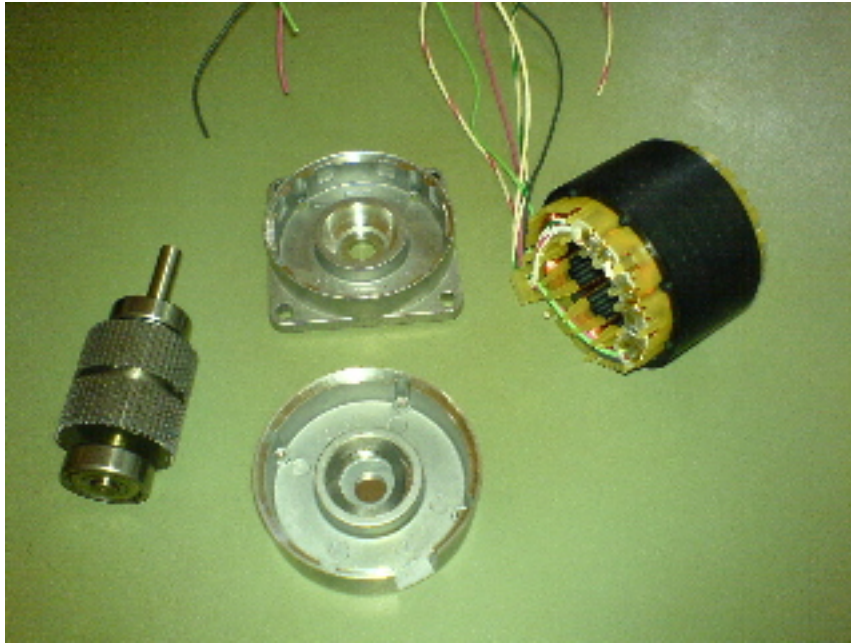

The stator has a set of coils (in this case eight) each of which energises a single pole. Those poles, in turn, each have four teeth. The windings on poles 1, 3, 5 & 7 are connected together: let's call this Phase A. Poles 2, 4, 6 & 8 are also connected together to form Phase B. There's then an external connection to each end of the two phases and to the centre-tap of the coils, making six wires in all.



The rotor also has a series of teeth that exactly correspond to teeth on the poles of the housing. However, not all the rotor teeth line up with all the stator teeth at any one time! In fact, the rotor teeth are in two sets, a front set and a back set. These two sets are rotated by half a tooth with respect to each other. Between the two sets is a permanent magnet, and so the front set corresponds to a north pole, and the rear set a south pole. (All this seems unnecessarily complicated, and it is. The only reasons it's done this way is so you can get nice small steps – in this case  $1.8^\circ$  at a time.)

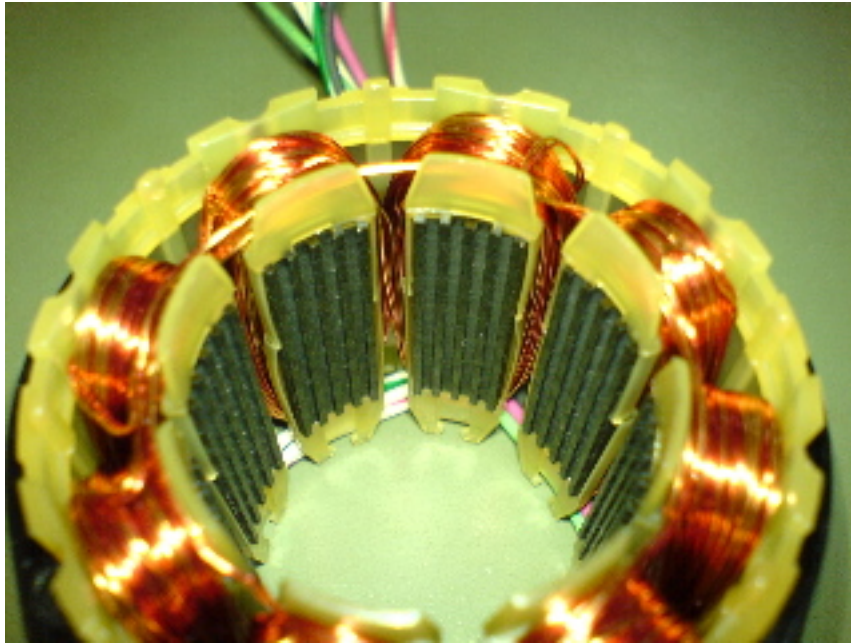

If we energise the Phase A coils, the rotor will turn so its teeth line up with the teeth of that phase. Now, if we energise Phase B as well, the rotor will turn slightly because the teeth of the Phase B are not aligned with those of Phase A. Now we de-energise Phase A, and the rotor will align fully with the teeth of Phase B. Next we energise Phase A with the reverse polarity to before, de-energise Phase B, energise Phase B with the reverse polarity, de-energise Phase A, re-energise Phase A with the original polarity, and we've made one full step! If we were writing this down as series of dance steps for a barn dance it would probably look something like: A+ A+B+ B+ A-B+ A- A-B- B- A+B- A+.

There are many other varieties of stepper motors. Some have no magnets on the rotor (so-called *switched reluctance* stepper motors), and some have magnets but no iron.

## 8. The infamous "ball bearing" motor

This motor is nothing more than a shaft supported by two ball bearings. Current is fed to the outside of one bearing, runs through the shaft, and out the other bearing. It sometimes needs a little kick to get it started, but once turning will run equally well in either direction.

Advantages:

- Perfect conversation-starter at parties
- Creates confusion amongst engineers

Disadvantages:

- Completely useless
- Requires staggeringly high currents to make it turn



This motor has no windings, brushes, magnets, and cannot possibly work. Except that it does. [Click here \(URL\)](#) for an explanation.



## 9. Taking motors apart.

This is not an exhaustive list. Always take extreme care when working around machinery. Wear protective glasses and think before you act. Below are a few safety tips that are important to observe when working with electric motors.

1. Before disassembling an electric motor, make sure you have owner's permission. This is really important – especially if you don't succeed in getting it back together again before they find out.
2. Disconnect the motor from the source of electricity. In necessary, cut wires off to ensure there can be no accidental reconnection. Never fool about with the mains.
3. In the case of permanent magnet motors, the magnets can be extremely powerful. Parts of the motor can unexpectedly slam together, trapping fingers and other sensitive body parts, or striking the eyes with metal splinters.
4. In many permanent magnet motors, simple disassembly and reassembly, even if you do it 100% right, will result in the magnetic field being weaker than before. Paradoxically, the motor will now spin *faster* than it did previously. This could lead to alarming results if, for example, the motor is part of your grandmother's electric wheel chair.
5. This one applies to any large inductor, including the windings of an electric motor. If you suddenly interrupt a current that is passing through an inductor (for example, if you are testing a winding with a battery and then disconnect the battery) a high voltage will appear briefly across the winding ( $V = -Ldi/dt$ ). This can kill you. Really. Ensure that you are not holding the bare wires when you are experimenting, even if the DC voltage is only 12 volts or so.
6. All rotating shafts are potentially dangerous - never be complacent where exposed shafts are concerned. Even a clean, smooth shaft can easily grab hair or clothing and cause serious injury. An induction motor inside a vacuum cleaner is pretty harmless (unless you're a mouse), but the same motor sitting on a bench is potentially lethal. For a start it's more powerful than you. Second, it has no common sense. Finally, remember that the torque the casing exerts on the rotor is exactly equal (and opposite) to the torque the rotor exerts on the casing. So, if the rotor is heavy (and it usually is), when you first switch the motor on the rotor tends to stay put while the casing rotates. Bolt it down first!

## The ball-bearing motor

How can a DC motor with no windings, magnets, commutators, or tricky electronics work? Over the years, folk have tried to explain this motor by invoking strange new interpretations of Maxwell's equations, or by creating tortured descriptions of magnetic fields that are generated by a current-carrying conductor and then somehow end up doing what no other magnetic field ever does. Other folk have related the phenomenon to Energies Unknown To Science, and hypothesised that this might be a way of tapping into unlimited free energy. Some of these explanations have even been published in reputable journals, before being soundly demolished in even more reputable journals.

In fact the explanation appears to be very simple, if a bit bizarre. Think *hot balls*. The current through the ball bearings (100 amps or more, for the motor in the photograph) is enough to heat them up. The current is flowing *radially* through each ball, causing preferential heating along the axis of the ball perpendicular to the shaft. The ball therefore momentarily expands into an ellipsoidal shape. If the shaft is already rotating, this expansion can occur along an axis that is fractionally *after* the pure perpendicular, giving a little "push" to the shaft as it does so.

Following this up on the WWW is a good rainy-day project, but don't believe everything you read!

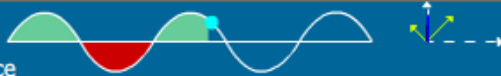

# Electric motors and generators

## From [Physclips](#): Mechanics with animations and film.

An introduction using animations and schematics to explain the physical principles of some of the different types of electric motors, generators, alternators, linear motors and loudspeakers.

- [Schematics and operation of different types of motor](#)
  - [DC motors](#)
  - [Motors and generators](#)
  - [Alternators](#)
  - [Back emf](#)
  - ['Universal' motors](#)
  - [Build a simple motor](#)
  - [AC motors \(synchronous and stepper motors\)](#)
  - [Induction motors](#)
  - [Squirrel cage motors](#)
  - [Three phase induction motors](#)
  - [Linear motors](#)
  - [Homopolar motors and generators](#) (separate page).
- [Loudspeakers](#)
- [Transformers](#)
- [AC vs DC generators](#)
- [Some web resources](#)

The schematics shown here are idealised, to make the principles obvious. For example, this animation has just one loop of wire, no bearings and a very simple geometry. Real motors use the same principles, but their geometry is usually complicated. If you already understand the basic principles of the various types of motors, you may want to go straight to the more complex and subtle cases described in [How real electric motors work](#), by Prof John Storey.

---

## DC motors

A simple DC motor has a coil of wire that can rotate in a magnetic field. The current in the coil is supplied via two brushes that make moving contact with a split ring. The coil lies in a steady magnetic field. The forces exerted on the current-carrying wires create a [torque](#) on the coil.

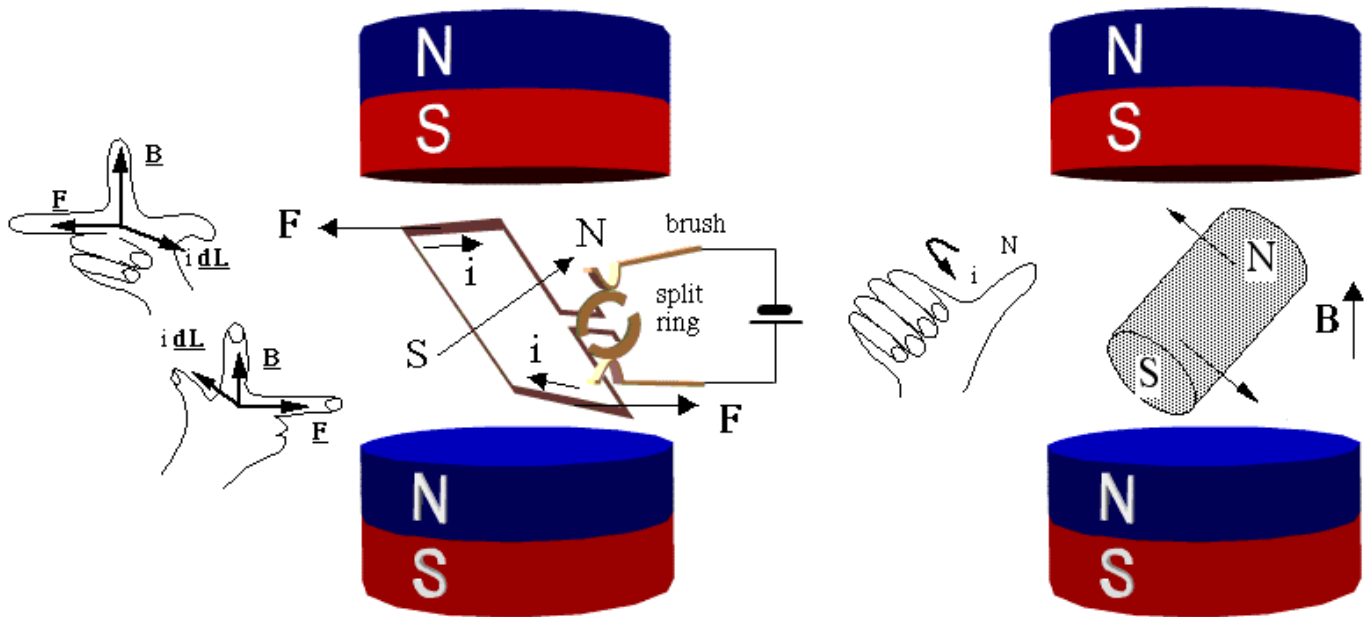

The force  $F$  on a wire of length  $L$  carrying a current  $i$  in a magnetic field  $B$  is  $iLB$  times the sine of the angle between  $B$  and  $i$ , which would be  $90^\circ$  if the field were uniformly vertical. The direction of  $F$  comes from the right hand rule, as shown here. The two forces shown here are equal and opposite, but they are displaced vertically, so they exert a [torque](#). (The forces on the other two sides of the coil act along the same line and so exert no torque.)

The coil can also be considered as a magnetic dipole, or a little electromagnet, as indicated by the arrow  $SN$ : curl the fingers of your right hand in the direction of the current, and your thumb is the North pole. In the sketch at right, the electromagnet formed by the coil of the rotor is represented as a permanent magnet, and the same torque (North attracts South) is seen to be that acting to align the central magnet.

Note the effect of the **brushes** on the **split ring**. When the plane of the rotating coil reaches horizontal, the brushes will break contact (not much is lost, because this is the point of zero torque anyway – the forces act inwards). The angular momentum of the coil carries it past this break point and the current then flows in the opposite direction, which reverses the magnetic dipole. So, after passing the break point, the rotor continues to turn anticlockwise and starts to align in the opposite direction. In the following text, I shall largely use the 'torque on a magnet' picture, but be aware that the use of brushes or of AC current can cause the poles of the electromagnet in question to swap position when the current changes direction.

The torque generated over a cycle varies with the vertical separation of the two forces. It therefore depends on the sine of the angle between the axis of the coil and field. However, because of the split ring, it is always in the same sense. The animation below shows its variation in time, and you can stop it at any stage and check the direction by applying the right hand rule.

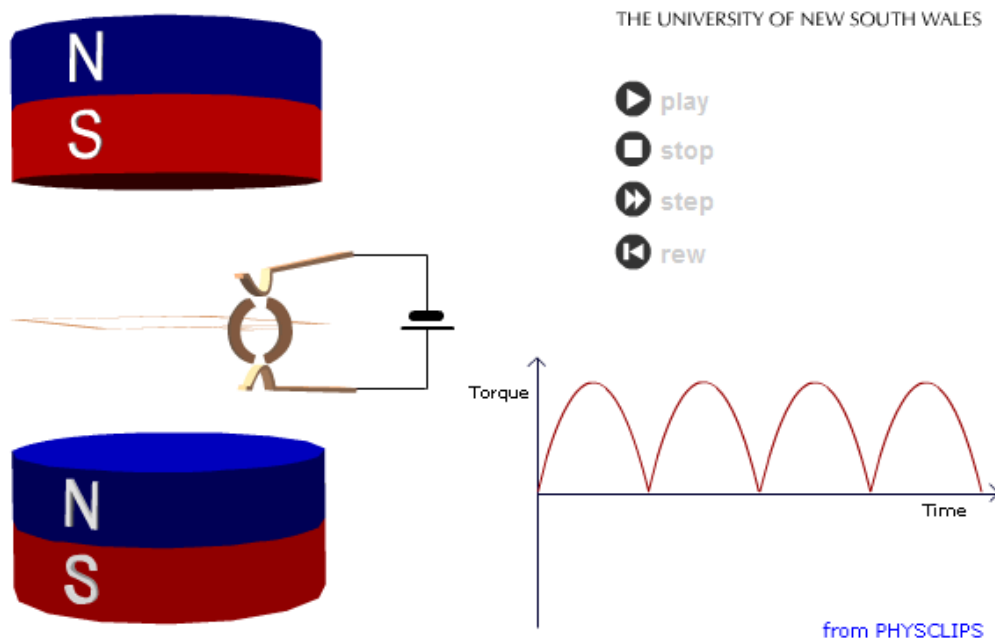

## Motors and generators

Now a DC motor is also a DC generator. Have a look at the next animation. The coil, split ring, brushes and magnet are exactly the same hardware as the motor above, but the coil is being turned, which generates an emf.

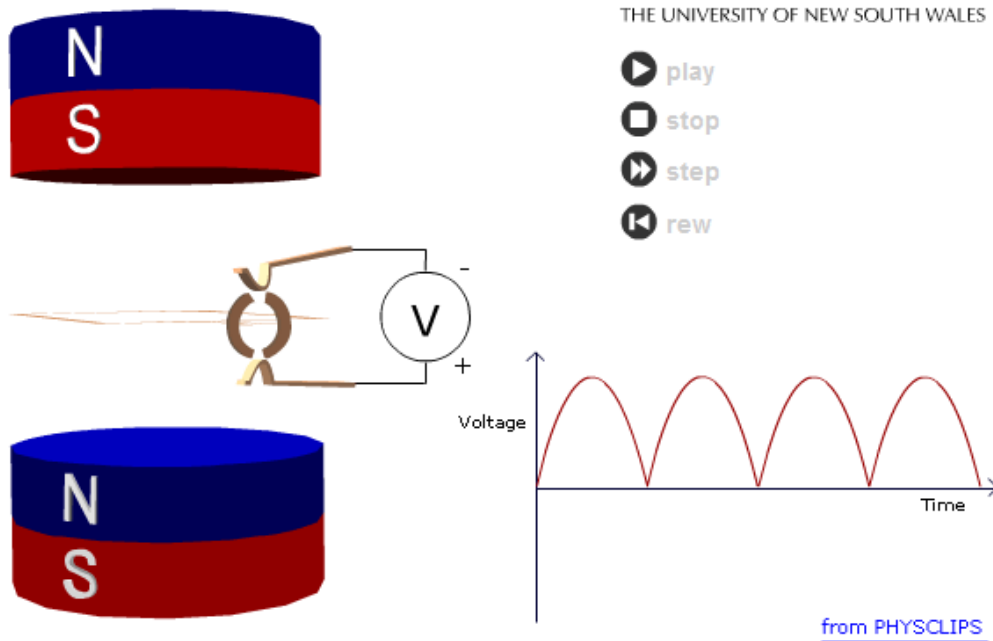

If you use mechanical energy to rotate the coil ( $N$  turns, area  $A$ ) at uniform angular velocity  $\omega$  in the magnetic field  $\mathbf{B}$ , it will produce a sinusoidal emf in the coil. emf (an emf or electromotive force is almost the same thing as a voltage). Let  $\theta$  be the angle between  $\mathbf{B}$  and the normal to the coil, so the magnetic flux  $\phi$  is  $NAB \cos \theta$ . Faraday's law gives:

$$\begin{aligned} \text{emf} &= -d\phi/dt = -(d/dt)(NBA \cos \theta) \\ &= NBA \sin \theta (d\theta/dt) = NBA\omega \sin \omega t. \end{aligned}$$

The animation above would be called a DC generator. As in the DC motor, the ends of the coil connect to a split ring, whose two halves are contacted by the brushes. Note that the brushes and split ring 'rectify' the emf produced: the contacts are organised so that the current will always flow in the same direction, because when the coil turns past the dead spot, where the brushes meet the gap in the ring, the connections between the ends of the coil and external terminals are reversed. The emf here (neglecting the dead spot, which conveniently happens at zero volts) is  $|NBA \omega \sin \omega t|$ , as sketched.

## An alternator

If we want AC, we don't need rectification, so we don't need split rings. ( This is good news, because the split rings cause sparks, ozone, radio interference and extra wear. If you want DC, it is often better to use an alternator and rectify with diodes.)

In the next animation, the two brushes contact two continuous rings, so the two external terminals are always connected to the same ends of the coil. The result is the unrectified, sinusoidal emf given by  $NBA\omega \sin \omega t$ , which is shown in the next animation.

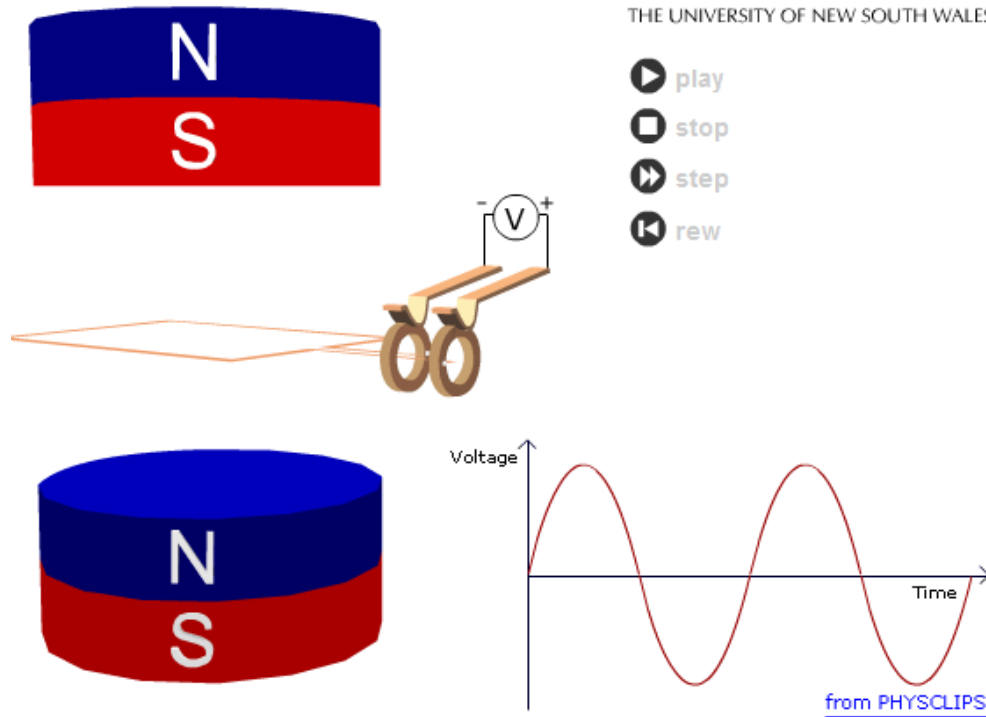

This is an AC generator. The advantages of [AC and DC generators](#) are compared in a section below. We saw above that a DC motor is also a DC generator. Similarly, an alternator is also an AC motor. However, it is a rather inflexible one. (See [How real electric motors work](#) for more details.)

## Back emf

Now, as the first two animations show, DC motors and generators may be the same thing. For example, the motors of trains become generators when the train is slowing down: they convert kinetic energy into electrical energy and put power back into the grid. Recently, a few manufacturers have begun making motor cars rationally. In such cars, the electric motors used to drive the car are also used to charge the batteries when the car is stopped - it is called regenerative braking.

So here is an interesting corollary. *Every motor is a generator.* This is true, in a sense, even when it functions as a motor. The emf that a motor generates is called the **back emf**. The back emf increases with the speed, because of Faraday's law. So, if the motor has no load, it turns very quickly and speeds up until the back emf, plus the voltage drop due to losses, equal the supply voltage. The back emf can be thought of as a 'regulator': it stops the motor turning infinitely quickly (thereby saving physicists some embarrassment). When the motor is loaded, then the phase of the voltage becomes closer to that of the current (it starts to look resistive) and this apparent resistance gives a voltage. So the back emf required is smaller, and the motor turns more slowly. (To add the back emf, which is inductive, to the resistive component, you need to add voltages that are out of phase. See [AC circuits](#).)

## Coils usually have cores

In practice, (and unlike the diagrams we have drawn), generators and DC motors often have a high permeability core inside the coil, so that large magnetic fields are produced by modest currents. This is shown at left in the figure below in which the **stators** (the magnets which are stationary) are permanent magnets.

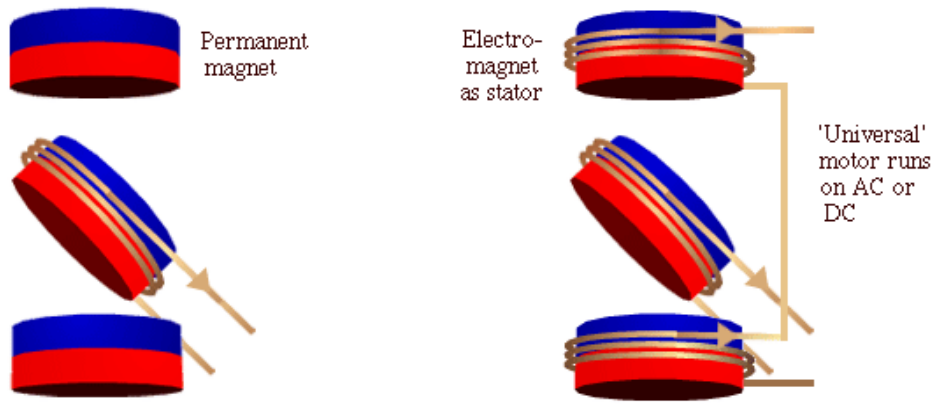

## 'Universal' motors

The stator magnets, too, could be made as electromagnets, as is shown above at right. The two stators are wound in the same direction so as to give a field in the same direction and the rotor has a field which reverses twice per cycle because it is connected to brushes, which are omitted here. One advantage of having wound stators in a motor is that one can make a motor that runs on AC or DC, a so called **universal motor**. When you drive such a motor with AC, the current in the coil changes twice in each cycle (in addition to changes from the brushes), but the polarity of the stators changes at the same time, so these changes cancel out. (Unfortunately, however, there are still brushes, even though I've hidden them in this sketch.) For advantages and disadvantages of permanent magnet versus wound stators, see [below](#). Also see [more on universal motors](#).

## Build a simple motor

To build this simple but strange motor, you need two fairly strong magnets (rare earth magnets about 10 mm diameter would be fine, as would larger bar magnets), some stiff copper wire (at least 50 cm), two wires with crocodile clips on either end, a six volt lantern battery, two soft drink cans, two blocks of wood, some sticky tape and a sharp nail.

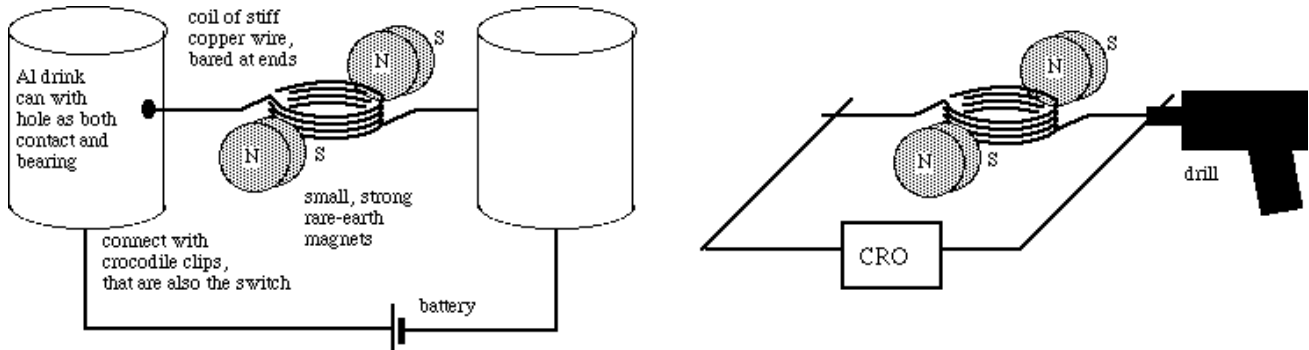

Make the coil out of stiff copper wire, so it doesn't need any external support. Wind 5 to 20 turns in a circle about 20 mm in diameter, and have the two ends point radially outwards in opposite directions. These ends will be both the axle and the contacts. If the wire has lacquer or plastic insulation, strip it off at the ends.

The supports for the axle can be made of aluminium, so that they make electrical contact. For example poke holes in a soft drink cans with a nail as shown. Position the two magnets, north to south, so that the magnetic field passes through the coil at right angles to the axles. Tape or glue the magnets onto the wooden blocks (not shown in the diagram) to keep them at the right height, then move the blocks to put them in position, rather close to the coil. Rotate the coil initially so that the magnetic flux through the coil is zero, as shown in the diagram.

Now get a battery, and two wires with crocodile clips. Connect the two terminals of the battery to the two metal supports for the coil and it should turn.



An alternative realisation of the simple motor, by James Taylor.

Note that this motor has at least one 'dead spot': It often stops at the position where there is no torque on the coil. Don't leave it on too long: it will flatten the battery quickly.

The optimum number of turns in the coil depends on the internal resistance of the battery, the quality of the support contacts and the type of wire, so you should experiment with different values.

As mentioned above, this is also a generator, but it is a very inefficient one. To make a larger emf, use more turns (you may need to use finer wire and a frame upon which to wind it.) You could use eg an electric drill to turn it quickly, as shown in the sketch above. Use an oscilloscope to look at the emf generated. Is it AC or DC?

This motor has no split ring, so why does it work on DC? Simply put, if it were exactly symmetrical, it wouldn't work. However, if the current is slightly less in one half cycle than the other, then the average torque will not be zero and, because it spins reasonably rapidly, the angular momentum acquired during the half cycle with greater current carries it through the half cycle when the torque is in the opposite direction. At least two effects can cause an asymmetry. Even if the wires are perfectly stripped and the wires clean, the contact resistance is unlikely to be exactly equal, even at rest. Also, the rotation itself causes the contact to be intermittent so, if there are longer bounces during one phase, this asymmetry is sufficient. In principle, you could partially strip the wires in such a way that the current would be zero in one half cycle.

**An even simpler motor** (one that is also much simpler to understand!) is the [homopolar motor](#).

## AC motors

With AC currents, we can reverse field directions without having to use brushes. This is good news, because we can avoid the arcing, the ozone production and the ohmic loss of energy that brushes can entail. Further, because brushes make contact between moving surfaces, they wear out.

The first thing to do in an AC motor is to create a rotating field. 'Ordinary' AC from a 2 or 3 pin socket is single phase AC--it has a single sinusoidal potential difference generated between only two wires--the active and neutral. (Note that the Earth wire doesn't carry a current except in the event of electrical faults.) With single phase AC, one can produce a rotating field by generating two currents that are out of phase using for example a capacitor. In the example shown, the two currents are  $90^\circ$  out of phase, so the vertical component of the magnetic field is sinusoidal, while the horizontal is cosinusoidal, as shown. This gives a field rotating counterclockwise.

(\* I've been asked to explain this: from simple [AC theory](#), neither coils nor capacitors have the voltage in phase with the current. In a capacitor, the voltage is a maximum when the charge has finished flowing onto the capacitor, and is about to start flowing off. Thus the voltage is behind the current. In a purely inductive coil, the voltage drop is greatest when the current is changing most rapidly, which is also when the current is zero. The voltage (drop) is ahead of the current. In motor coils, the phase angle is rather less than  $90^\circ$ , because



electrical energy is being converted to mechanical energy.)

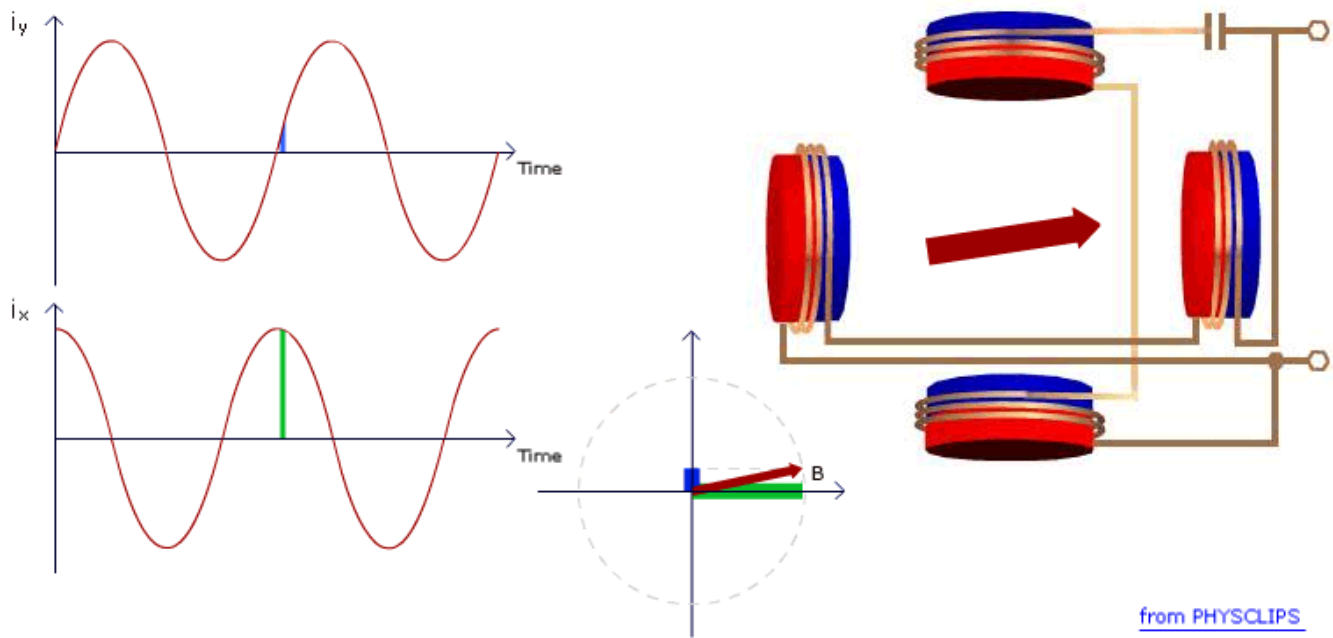

In this animation, the graphs show the variation in time of the currents in the vertical and horizontal coils. The plot of the field components  $B_x$  and  $B_y$  shows that the vector sum of these two fields is a rotating field. The main picture shows the rotating field. It also shows the polarity of the magnets: as above, blue represents a North pole and red a South pole.

If we put a permanent magnet in this area of rotating field, or if we put in a coil whose current always runs in the same direction, then this becomes a **synchronous motor**. Under a wide range of conditions, the motor will turn at the speed of the magnetic field. If we have a lot of stators, instead of just the two pairs shown here, then we could consider it as a stepper motor: each pulse moves the rotor on to the next pair of actuated poles. Please remember my warning about the idealised geometry: real stepper motors have dozens of poles and quite complicated geometries!

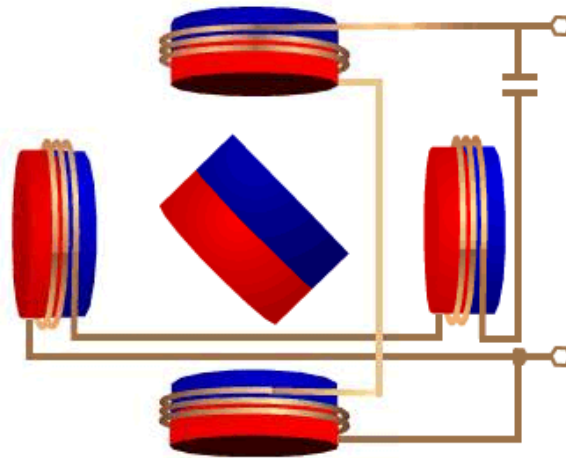

from PHYSCLIPS

## Induction motors

Now, since we have a time varying magnetic field, we can use the induced emf in a coil – or even just the eddy currents in a conductor – to make the rotor a magnet. That's right, once you have a rotating magnetic field, you can just put in a conductor and it turns. This gives several of the **advantages of induction motors**: no brushes or commutator means easier manufacture, no wear, no sparks, no ozone production and none of the energy loss associated with them. Below left is a schematic of an induction motor. (For photos of real induction motors and more details, see [Induction motors](#).)

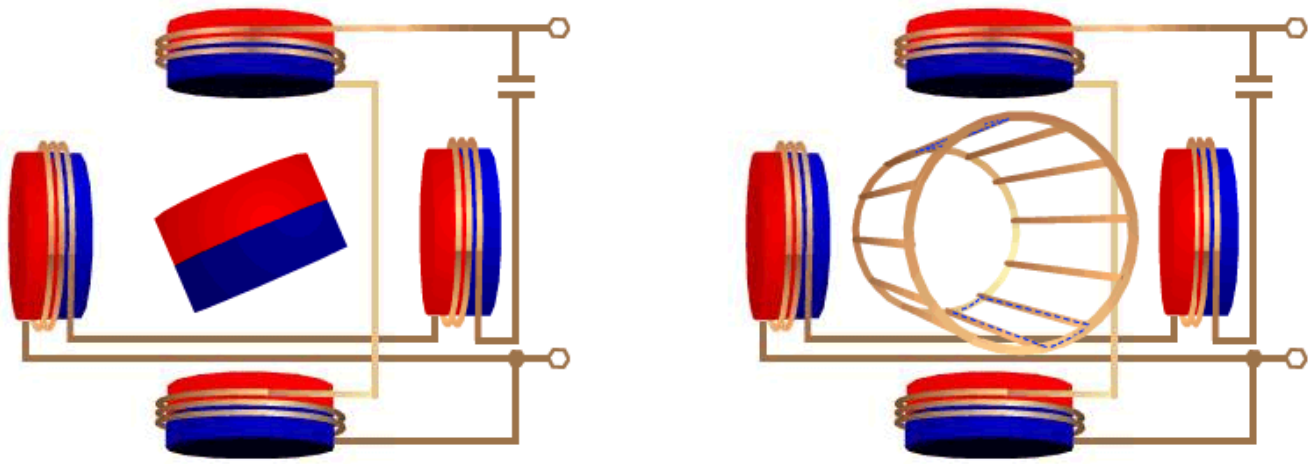

from PHYSCLIPS

The animation at right represents a **squirrel cage motor**. The squirrel cage has (in this simplified geometry, anyhow!) two circular conductors joined by several straight bars. Any two bars and the arcs that join them form a coil – as indicated by the blue dashes in the animation. (Only two of the many possible circuits have been shown, for simplicity.)

This schematic suggests why they might be called squirrel cage motors. The reality is different: for photos and more details, see [Induction motors](#). The problem with the induction and squirrel cage motors shown in this animation is that capacitors of high value and high voltage rating are expensive. One solution is the 'shaded pole' motor, but its rotating field has some directions where the torque is small, and it has a tendency to run backwards under some conditions. The neatest way to avoid this is to use multiple phase motors.

### Three phase AC induction motors

Single phase is used in domestic applications for low power applications but it has some drawbacks. One is that it turns off 100 times per second (you don't notice that the fluorescent lights flicker at this speed because your eyes are too slow: even 25 pictures per second on the TV is fast enough to give the illusion of continuous motion.) The second is that it makes it awkward to produce rotating magnetic fields. For this reason, some high power (several kW) domestic devices may require three phase installation. Industrial applications use three phase extensively, and the three phase induction motor is a standard workhorse for high power applications. The three wires (not counting earth) carry three possible potential differences which are out of phase with each other by  $120^\circ$ , as shown in the animation below. Thus three stators give a smoothly rotating field. (See [this link](#) for more about three phase supply.)

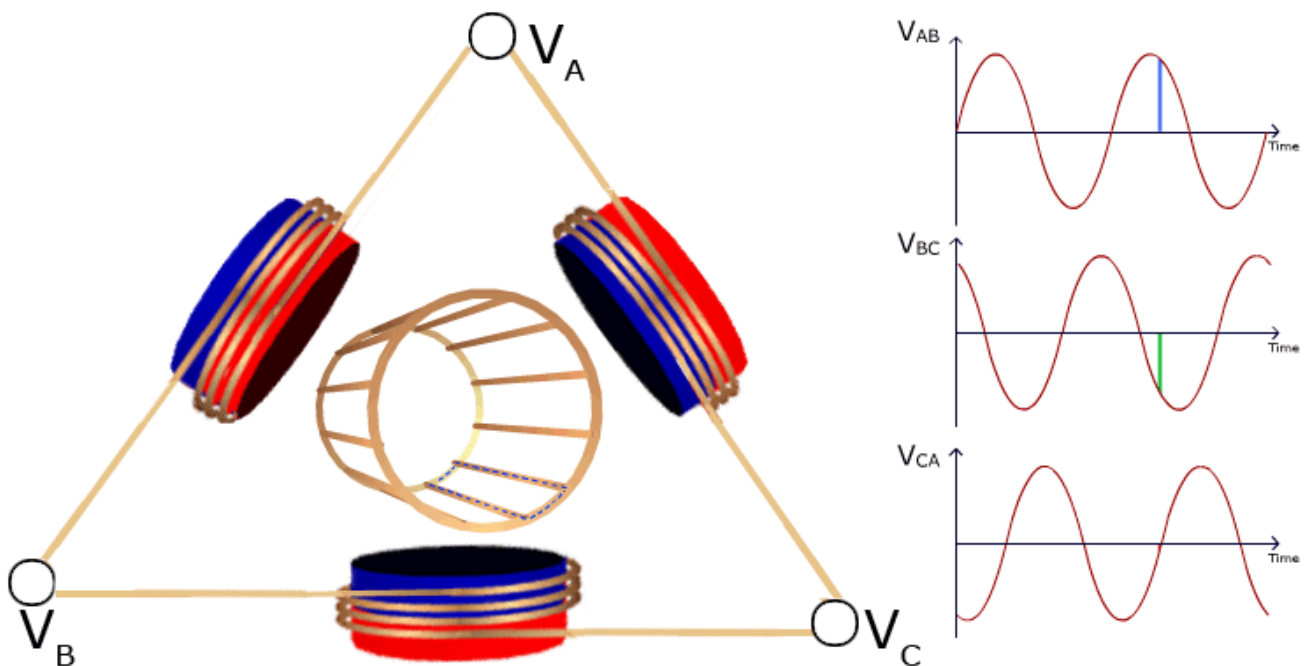

from PHYSCLIPS

If one puts a permanent magnet in such a set of stators, it becomes a **synchronous three phase motor**. The animation shows a squirrel cage, in which for simplicity only one of the many induced current loops is shown. With no mechanical load, it is turning virtually in phase with the rotating field. The rotor need not be a squirrel cage: in fact any conductor that will carry eddy currents will rotate, tending to follow the rotating field. This arrangement can give an **induction motor** capable of high efficiency, high power and high torques over a range of rotation rates.

## Linear motors

A set of coils can be used to create a magnetic field that translates, rather than rotates. The pair of coils in the animation below are pulsed on, from left to right, so the region of magnetic field moves from left to right. A permanent or electromagnet will tend to follow the field. So would a simple slab of conducting material, because the eddy currents induced in it (not shown) comprise an electromagnet. Alternatively, we could say that, from Faraday's law, an emf in the metal slab is always induced so as to oppose any change in magnetic flux, and the forces on the currents driven by this emf keep the flux in the slab nearly constant. (Eddy currents not shown in this animation.)

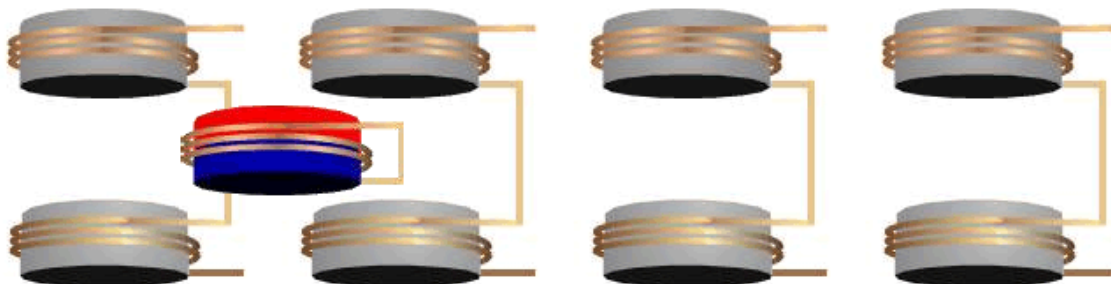

Alternatively, we could have sets of powered coils in the moving part, and induce eddy currents in the rail. Either case gives us a linear motor, which would be useful for say maglev trains. (In the animation, the geometry is, as usual on this site, highly idealised, and only one eddy current is shown.)

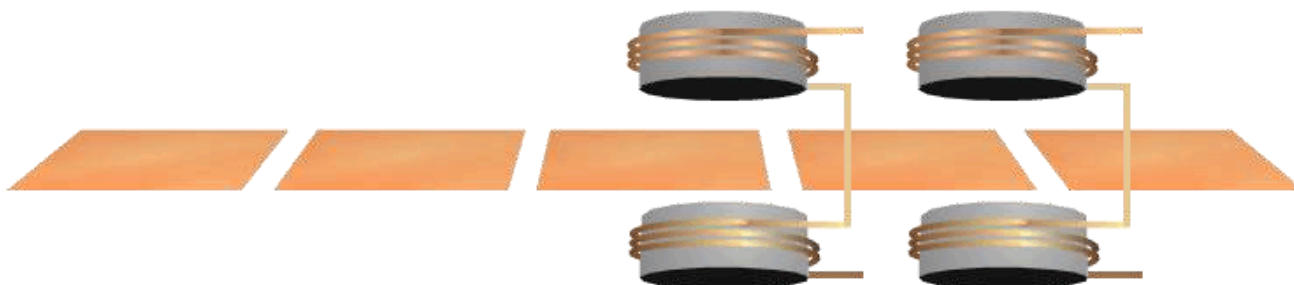

## Some notes about AC and DC motors for high power applications

This site was originally written to help high school students and teachers in New South Wales, Australia, where a new syllabus concentrating on the history and applications of physics, at the expense of physics itself, has been introduced. The new syllabus, in one of the dot points, has this puzzling requirement: "explain that AC motors usually produce low power and relate this to their use in power tools".

AC motors are used for high power applications whenever it is possible. Three phase AC induction motors are widely used for high power applications, including heavy industry. However, such motors are unsuitable if multiphase is unavailable, or difficult to deliver. Electric trains are an example: it is easier to build power lines and pantographs if one only needs one active conductor, so this usually carries DC, and many train motors are DC. However, because of the disadvantages of DC for high power, more modern trains convert the DC into AC and then run three phase motors.

Single phase induction motors have problems for applications combining high power and flexible load conditions. The problem lies in producing the rotating field. A capacitor could be used to put the current in one set of coils ahead, but high value, high voltage capacitors are expensive. Shaded poles are used instead, but the torque is small at some angles. If one cannot produce a smoothly rotating field, and if the load 'slips' well behind the field, then the torque falls or even reverses.

Power tools and some appliances use brushed AC motors. Brushes introduce losses (plus arcing and ozone production). The stator

polarities are reversed 100 times a second. Even if the core material is chosen to minimise hysteresis losses ('iron losses'), this contributes to inefficiency, and to the possibility of overheating. These motors may be called ['universal' motors](#) because they can operate on DC. This solution is cheap, but crude and inefficient. For relatively low power applications like power tools, the inefficiency is usually not economically important.

If only single phase AC is available, one may rectify the AC and use a DC motor. High current rectifiers used to be expensive, but are becoming less expensive and more widely used. If you are confident you understand the principles, it's time to go to [How real electric motors work](#) by John Storey. Or else continue here to find out about loudspeakers and transformers.

## Loudspeakers

A loudspeaker is a linear motor with a small range. It has a single moving coil that is permanently but flexibly wired to the voltage source, so there are no brushes.



The coil moves in the field of a permanent magnet, which is usually shaped to produce maximum force on the coil. The moving coil has no core, so its mass is small and it may be accelerated quickly, allowing for high frequency motion. In a loudspeaker, the coil is attached to a light weight paper cone, which is supported at the inner and outer edges by circular, pleated paper 'springs'. In the photograph below, the speaker is beyond the normal upward limit of its travel, so the coil is visible above the magnet poles.

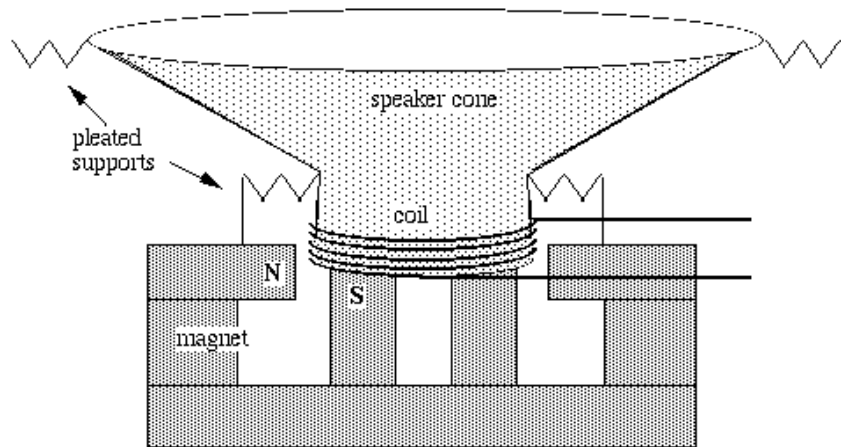

For low frequency, large wavelength sound, one needs large cones. The speaker shown below is 380 mm diameter. Speakers designed for low frequencies are called woofers. They have large mass and are therefore difficult to accelerate rapidly for high frequency sounds. In the photograph below, a section has been cut away to show the internal components.

Tweeters - loudspeakers designed for high frequencies - may be just speakers of similar design, but with small, low mass cones and coils. Alternatively, they may use piezoelectric crystals to move the cone.

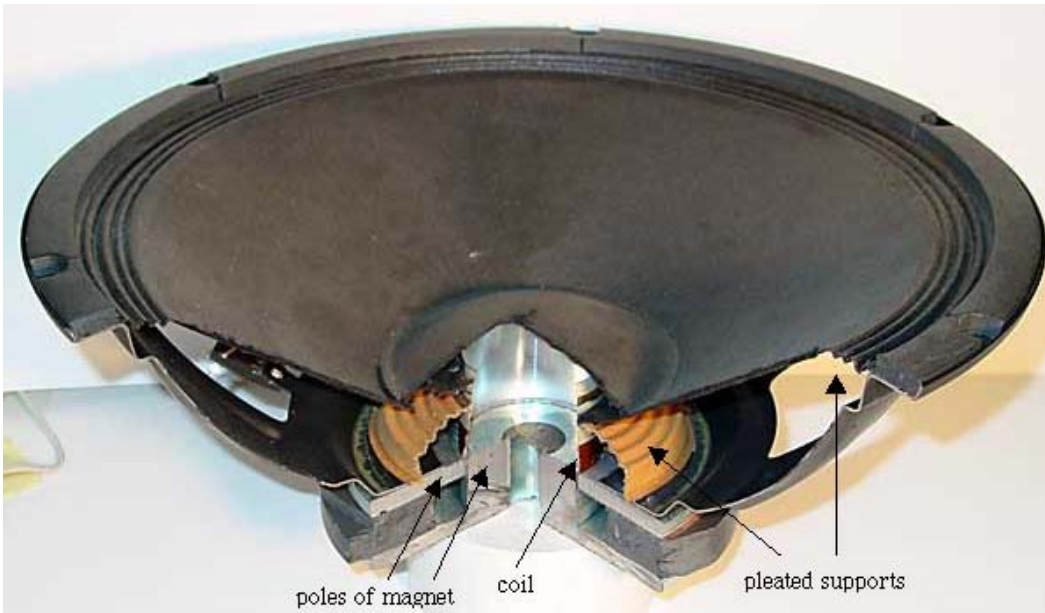

Speakers are seen to be linear motors with a modest range - perhaps tens of mm. Similar linear motors, although of course without the paper cone, are often used to move the reading and writing head radially on a disc drive.

### Warning: real motors are more complicated

The sketches of motors have been schematics to show the principles. Please don't be angry if, when you pull a motor apart, it looks more complicated! (See [How real electric motors work.](#)) For instance, a typical DC motor is likely to have many separately wound coils to produce smoother torque: there is always one coil for which the sine term is close to unity. This is illustrated below for a motor with wound stators (above) and permanent stators (below).

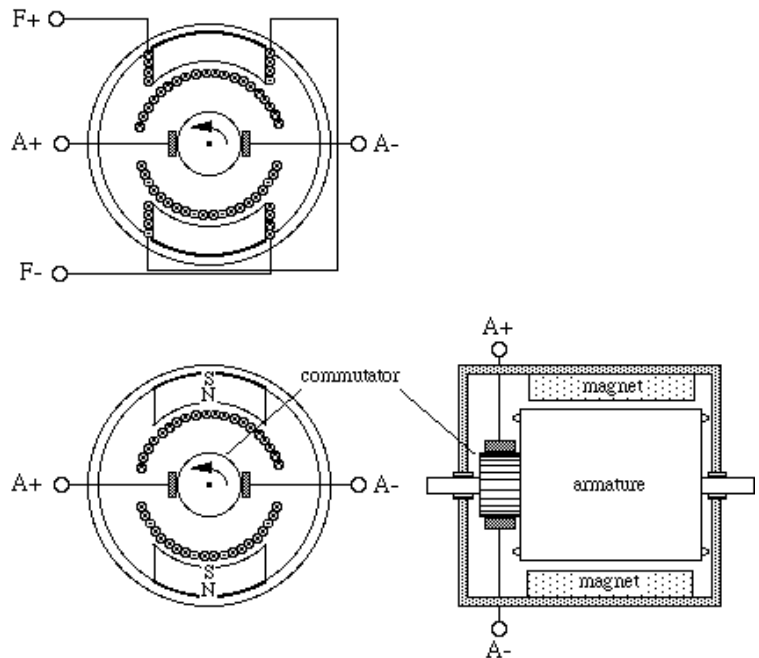

## Transformers

The photograph shows a transformer designed for demonstration purposes: the primary and secondary coils are clearly separated, and may be removed and replaced by lifting the top section of the core. For our purposes, note that the coil on the left has fewer coils than that at right (the insets show close-ups).

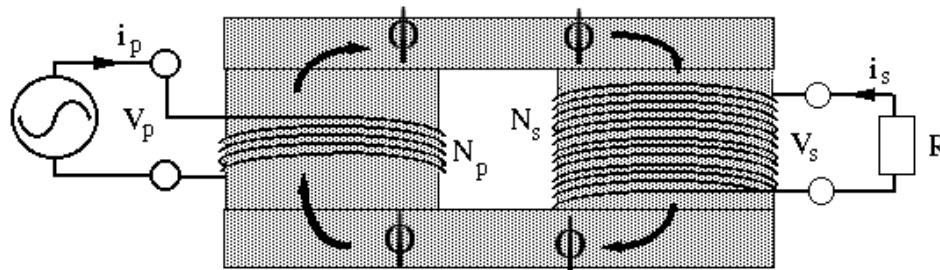

The sketch and circuit show a step-up transformer. To make a step-down transformer, one only has to put the source on the right and the load on the left. (**Important safety note:** for a real transformer, you could only 'plug it in backwards' only after verifying that the voltage rating were appropriate.) So, how does a transformer work?

The core (shaded) has high magnetic permeability, ie a material that forms a magnetic field much more easily than free space does, due to the orientation of atomic dipoles. (In the photograph, the core is laminated soft iron.) The result is that the field is concentrated inside the core, and almost no field lines leave the core. It follows that the magnetic fluxes  $\phi$  through the primary and secondary are approximately equal, as shown. From Faraday's law, the emf in each turn, whether in the primary or secondary coil, is  $-\text{d}\phi/\text{d}t$ . If we neglect resistance and other losses in the transformer, the terminal voltage equals the emf. For the  $N_p$  turns of the primary, this gives

$$V_p = -N_p \cdot \text{d}\phi/\text{d}t .$$

For the  $N_s$  turns of the secondary, this gives

$$V_s = -N_s \cdot \text{d}\phi/\text{d}t$$

Dividing these equations gives the **transformer equation**

$$V_s/V_p = N_s/N_p = r .$$

where  $r$  is the turns ratio. What about the current? If we neglect losses in the transformer (see the section below on efficiency), and if we assume that the voltage and current have similar phase relationships in the primary and secondary, then from conservation of energy we may write, in steady state:

$$\text{Power in} = \text{power out}, \quad \text{so}$$

$$V_p I_p = V_s I_s, \quad \text{whence}$$

$$I_s/I_p = N_p/N_s = 1/r .$$

So you don't get something for nothing: if you increase the voltage, you decrease the current by (at least) the same factor. Note that, in the photograph, the coil with more turns has thinner wire, because it is designed to carry less current than that with fewer turns.

In some cases, decreasing the current is the aim of the exercise. In power transmission lines, for example, the power lost in heating the wires due to their non-zero resistance is proportional to the square of the current. So it saves a lot of energy to transmit the electrical power from power station to city at very high voltages so that the currents are only modest.

Finally, and again assuming that the transformer is ideal, let's ask what the resistor in the secondary circuit 'looks like' to the primary circuit. In the primary circuit:

$$V_p = V_s/r \quad \text{and} \quad I_p = I_s \cdot r \quad \text{so}$$

$$V_p/I_p = V_s/r^2 I_s = R/r^2.$$

$R/r^2$  is called the **reflected resistance**. Provided that the frequency is not too high, and provided that there is a load resistance (conditions usually met in practical transformers), the inductive reactance of the primary is much smaller than this reflected resistance, so the primary circuit behaves as though the source were driving a resistor of value  $R/r^2$ .

### Efficiency of transformers

In practice, real transformers are less than 100% efficient.

- First, there are resistive losses in the coils (losing power  $I^2 \cdot r$ ). For a given material, the resistance of the coils can be reduced by making their cross section large. The resistivity can also be made low by using high purity copper. (See [Drift velocity and Ohm's law](#).)
- Second, there are some eddy current losses in the core. These can be reduced by laminating the core. Laminations reduce the area of circuits in the core, and so reduce the Faraday emf, and so the current flowing in the core, and so the energy thus lost.
- Third, there are hysteresis losses in the core. The magnetisation and demagnetisation curves for magnetic materials are often a little different (hysteresis or history dependence) and this means that the energy required to magnetise the core (while the current is increasing) is not entirely recovered during demagnetisation. The difference in energy is lost as heat in the core.
- Finally, the geometric design as well as the material of the core may be optimised to ensure that the magnetic flux in each coil of the secondary is nearly the same as that in each coil of the primary.

### More about transformers: AC vs DC generators

Transformers only work on AC, which is one of the great advantages of AC. Transformers allow 240V to be stepped down to convenient levels for digital electronics (only a few volts) or for other low power applications (typically 12V). Transformers step the voltage up for transmission, as mentioned above, and down for safe distribution. Without transformers, the waste of electric power in distribution networks, already high, would be enormous. It is possible to convert voltages in DC, but more complicated than with AC. Further, such conversions are often inefficient and/or expensive. AC has the further advantage that it can be used on AC motors, which are usually preferable to DC motors for high power applications.

---

### Other resources from us

- [How real electric motors work](#) by John Storey. This site has many photos of real motors and discussions of their complexities, advantages and disadvantages.
- [Physclips – waves and sound](#). This is our new project, which begins with the chapter on oscillations.
- [FAQ for high school physics](#). Originally set up for teachers and students using the New South Wales syllabus.
- [A Q & A bulletin board for high school physics problems](#). Originally set up for teachers and students using the New South Wales syllabus.
- [Main AC site](#).
- [RC filters, integrators and differentiators](#).
- [LC resonance](#).
- [Power in AC circuits, RMS values](#).
- Link to [Joe's educational pages](#) .

### Some external links to web resources on motors and generators

- [HyperPhysics: Electric Motors](#) from the HyperPhysics site at Georgia State. **Excellent site** overall, and the motor section is ideal

for this purpose. Good use of web graphics. Does DC, AC and induction motors and has extensive links

- [Loudspeakers.](#) More good stuff from Georgia State Hyperphysics. Nice graphics, good explanations and links. This [loudspeaker site](#) also includes enclosures.
- <http://members.tripod.com/simplemotor/rsmotor.htm> A site describing a student-built motor. Links to other motors built by the same student and links also to sites about motors.
- <http://www.specamotor.com> A site that sorts motors from various manufacturers according to specifications input by the user.

---

What is the difference between having permanent magnets and having electromagnets in a DC motor? Does it make it more efficient or more powerful? Or just cheaper?

When I received this question on the [High School Physics bulletin board](#), I sent it to [John Storey](#) who, as well as being a distinguished astronomer, is a builder of electric cars. Here's his answer:

In general, for a small motor it is much cheaper to use permanent magnets. Permanent magnet materials are continuing to improve and have become so inexpensive that even the government will on occasion send you pointless fridge magnets through the post. Permanent magnets are also more efficient, because no power is wasted generating the magnetic field. So why would one ever use a wound-field DC motor? Here's a few reasons:

- If you're building a really big motor you need a very big magnet and at some point a wound field might become cheaper, especially if a very high magnetic field is needed to create a large torque. Keep this in mind if you're designing a train. For this reason most cars have starter motors that use a wound field (although some modern cars are now using permanent magnet motors).
- With a permanent magnet the magnetic field has a fixed value (that's what "permanent" means!) Recall that the torque produced by the motor of a given geometry is equal to the product of the current through the armature and the magnetic field strength. With a wound-field motor you have the option of changing the current through the field, and hence changing the motor characteristics. This leads a range of interesting possibilities; do you put the field winding in series with the armature, in parallel, or feed it from a separately controlled source? As long as there is enough torque to overcome the load placed on the motor, internal friction etc., the weaker the magnetic field the \*faster\* the motor will spin (at fixed voltage). This may seem weird at first, but it's true! So, if you want a motor that can produce a lot of torque at standstill, yet spin to high speeds when the load is low (how's that train design coming?) perhaps a wound field is the answer.
- If you want to be able to run your motor from both AC and DC (the so-called "universal" motor), the magnetic field has to reverse its polarity every half cycle of the AC power, in order that the torque on the rotor is always in the same direction. Obviously you need a wound-field motor to achieve this trick.

---

Opinions expressed in these notes are mine and do not necessarily reflect the policy of the University of New South Wales or of the School of Physics. The animations were made by [George Hatsidimitris](#).

[Joe Wolfe](#) / [J.Wolfe@unsw.edu.au](mailto:J.Wolfe@unsw.edu.au) / 61-2-9385 4954 (UT + 10, +11 Oct-Mar)

---

[Physclips Home](#) [Site map for supporting pages](#)

[The Australian Learning and Teaching Council](#)

© [School of Physics](#) - [UNSW](#) 2052

[Disclaimer](#) [Feedback](#)

